

Installation Guidelines

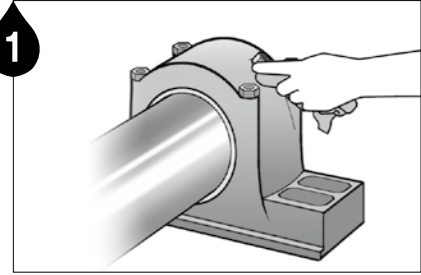

Remove contaminants around the lube point.

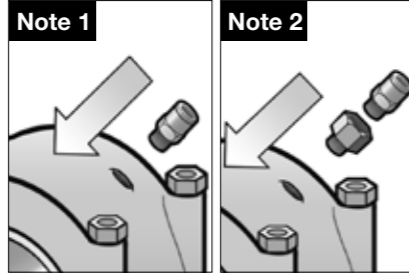

Note 1 Install A240, a push-in type tube fitting, directly onto the lube point.

Note 2 If necessary, use appropriate adaptors to install A240.

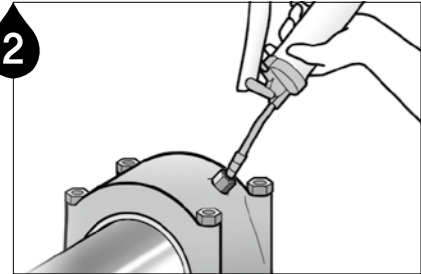

Ensure a clear passage using a manual grease gun. **Note 1** Remove any hardened grease by purging the lube point with a manual grease gun.

Note 2 The grease in the equipment and the grease contained in the unit should be the same or compatible.

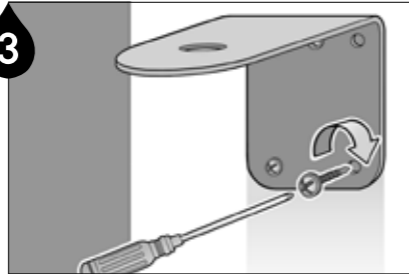

Install the mounting bracket (B002) at a proper location using screws (B051).

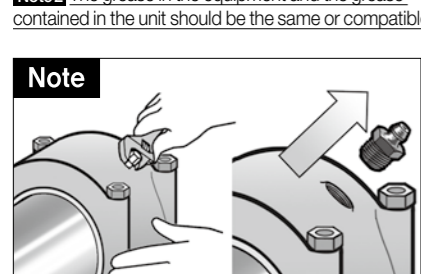

Remove the grease nipple.

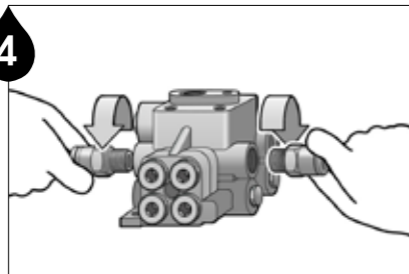

Screw in the push-in fitting connectors to each port of the divider block.

Note 1 It is recommended to seal the connected fittings using a thread sealant product (Loctite 572,577).

Note 2 Use a 90° push-in swivel fitting when applicable.

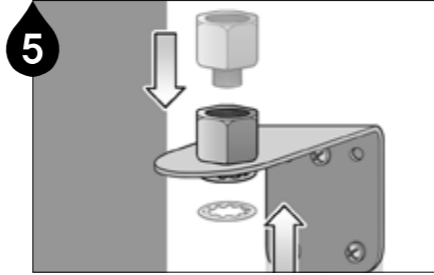

Install the adaptor (A002) on the fixed mounting bracket with the washer (B058) on the bottom.

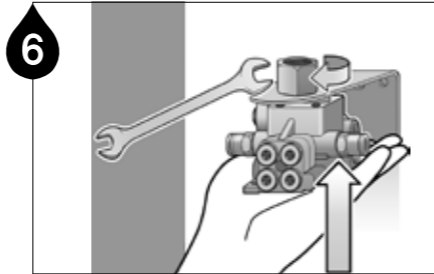

Connect the divider block to the adaptor, washer, and mounting bracket and turn the adaptor (A002) clockwise to tighten.

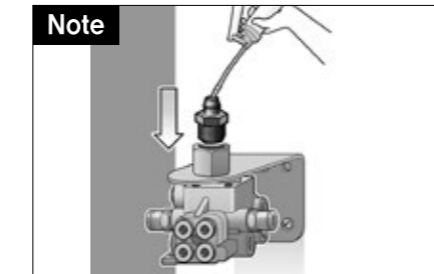

Prefill the divider block with the same or compatible grease using a grease gun and a 3/8" grease nipple.

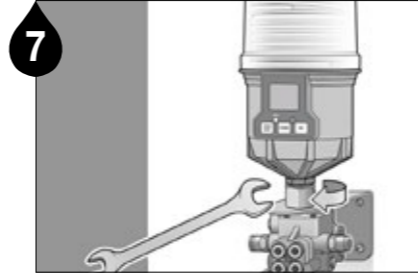

Install the lubricator onto the mounting bracket using a 17mm wrench.

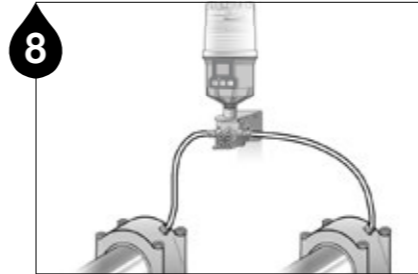

For typical bearing applications, install the divider block to the equipment using either copper or nylon tubes.

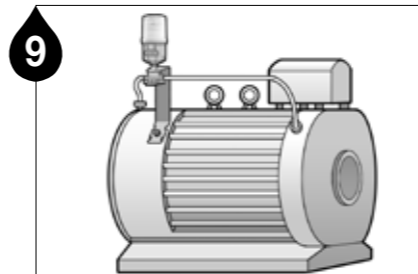

For motor bearing applications, install the mounting bracket at a proper location using the 2 point remote installation kit and then connect the lube-lines to both bearings.

Mounting Method

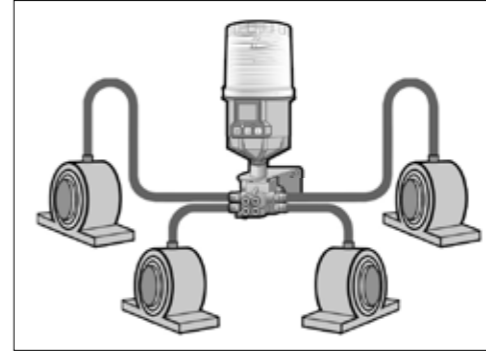

Multi-Point Installation

Remote multi-point lubrication is available with the Pulsarlube M using a divider block. It is recommended to test the back pressure of the bearing, lube lines, and divider block after assembly using a grease gun connected to a pressure gauge. Ensure the break-off pressure is below the average operating pressure of 30bar (435psi).

Warning

- ▶ Do not plug any open ports on the divider block. The kit or divider block must be ordered with the appropriate number of points required.
- ▶ For remote installation using a 6mm I.D. tubing, keep the maximum distance at 6m (20ft) or less.
- ▶ Prior to installation, ensure a clear passage using a manual grease gun and be sure to test the lubricator for proper operation.

Divider Block Grease Volume

Part No.	Outlet No.	
DU - 2RS	1 / 2	
DU - 3RS	1 / 2 / 5	No.2 / twice as much
DU - 4RS	1 / 2 / 5 / 6	
DU - 5RS	1 / 2 / 3 / 5 / 6	No.3 / twice as much
DU - 6RS	1 / 2 / 3 / 5 / 6 / 7	
DU - 7RS	1 / 2 / 3 / 5 / 6 / 7 / 8	No.8 / twice as much
DU - 8RS	1 / 2 / 3 / 4 / 5 / 6 / 7 / 8	

Note 1 The average dispensing volume of each port is about 0.3ml EXCEPT No.2 of DU-3RS, No.3 of DU-5RS, and No.8 of DU-7RS. The three ports above will dispense double the amount of grease as the other ports.

Note 2 The Outlet No. is shown near each port on the divider block.

Detailed Parts

No.	Part No.	Available Kits & Component Parts						
		1250MD-2	1250MD-3	1250MD-4	1250MD-5	1250MD-6	1250MD-7	1250MD-8
①	M unit	Sold separately						
②	A002	1ea						
③	B002	1ea						
④	B051	3ea						
⑤	B058	1ea						
⑥	A240	4ea	6ea	8ea	10ea	12ea	14ea	16ea
⑦	DU-XRS	DU-2RS	DU-3RS	DU-4RS	DU-5RS	DU-6RS	DU-7RS	DU-8RS
⑧	A243 (USA only)	2ea	3ea	4ea	5ea	6ea	7ea	8ea
⑨	A214-1	1ea	2ea	2ea	3ea	3ea	4ea	4ea

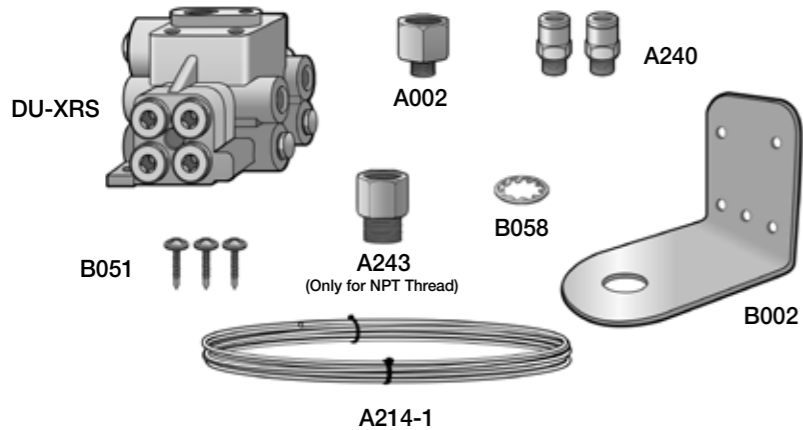

Warranty Product warranty is limited to original defects in material and workmanship and will not cover any collateral damage due to mishandling, abuse and /or any other inappropriate use of this product.

PULSARLUBE

The World Leader of Automatic Lubrication

Pulsarlube USA, Inc.

1170 Ardmore Ave Itasca IL 60143, USA
 TEL:1-847-593-5300 FAX:1-847-593-5303 www.pulsarlube.com/ info@pulsarlube.com

PULSARLUBE

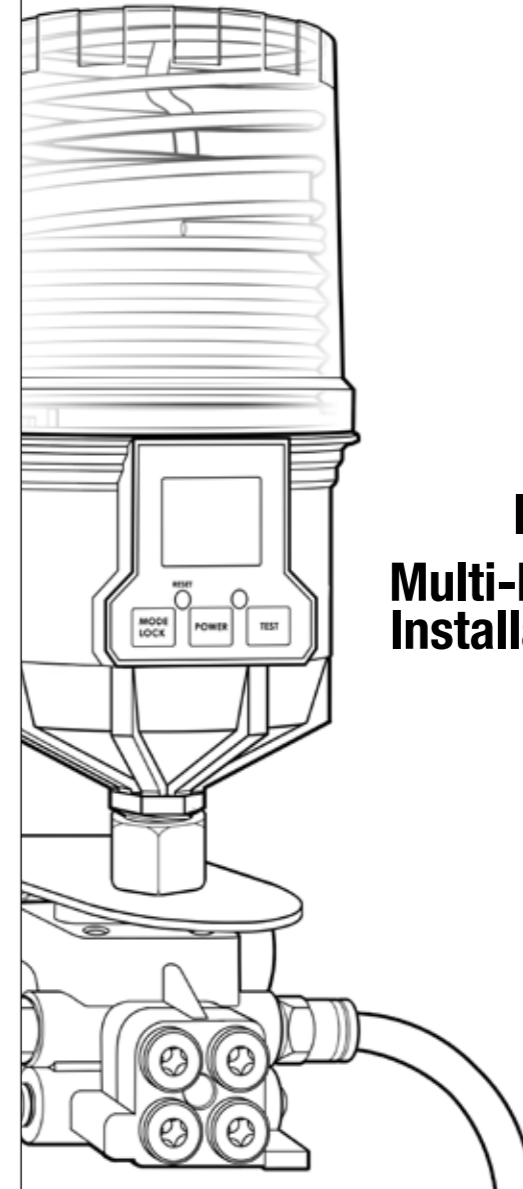

User Manual

Multi-Point Remote Installation Manual